

Orientalmotor

Electric Gripper
EH Series
*α*STEP AZ Series Equipped



Delicate grip.



Delicate, human-like grip.



Electric Gripper **EH Series**

*α*STEP AZ Series Equipped

A rack-and-pinion mechanism equipped with an **AZ** Series motor combined with an **EH** Series electric gripper. Its delicate grip, like that of a human hand, assists in automation and labor-saving.



Driven by an *α*STEP **AZ** Series Motor.

- Built-in battery-free absolute sensor, for constant monitoring of motor position information without an external sensor
- High reliability with closed loop control
- High efficiency technology reduces motor heat generation and saves energy

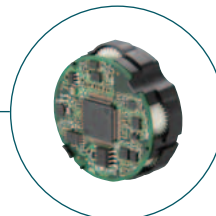
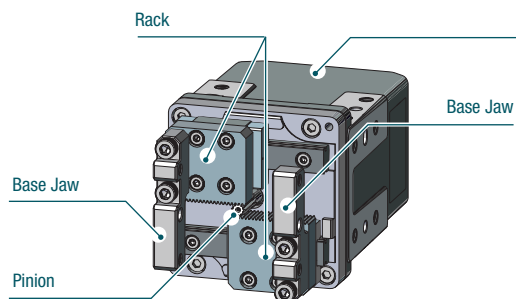

Battery-Free Absolute Sensor
(ABZO Sensor)

The electric gripper driver and cables are the same as for the **AZ** Series.



Please see the individual catalog for the **AZ** Series or the Oriental Motor website for the following.

- Driver specifications
- RS-485 Communication specifications
- Dimensions (driver, connection cable)
- Connection and Operation
- Cables

The On-Board AZ Series Provides a Delicate Grip.

A delicate grip is achieved by fine-tuning the grip force in 1% operating current increments and implementing a slow approach to the load.

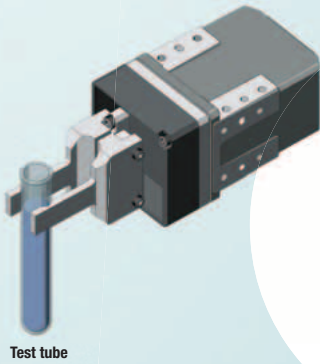

1

Grip

Delicate loads that may be damaged or deform easily can be gripped.

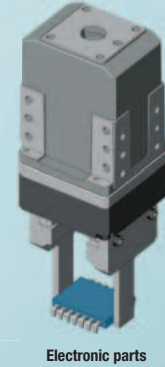
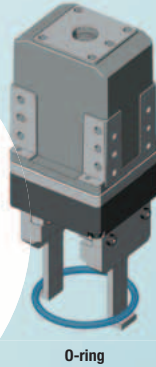

2

Adjust

The direction and position of the load can be coordinated.

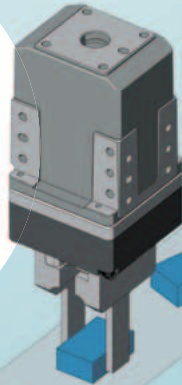

3

Measure

It is possible to measure the size of a load.

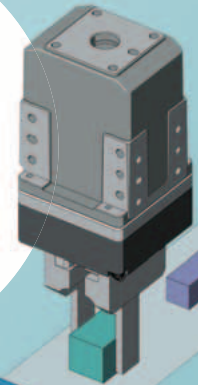

Contributes to the Reduction of Equipment Size.

Small and Lightweight

91 mm × 46 mm × 48.5 mm in size, and weighs 380 g.

The combination of a motor with a frame size of 28 mm and the rack-and-pinion mechanism results in smaller equipment. With a 25 mm stroke available to grip the load.

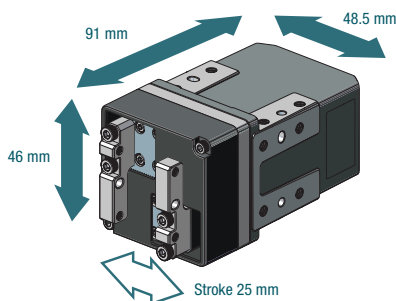

Multi-Surface Installation OK

Installation in various directions is possible.

The design is compatible with multi-surface installation, making it ideal for installation on robotic arms, etc.

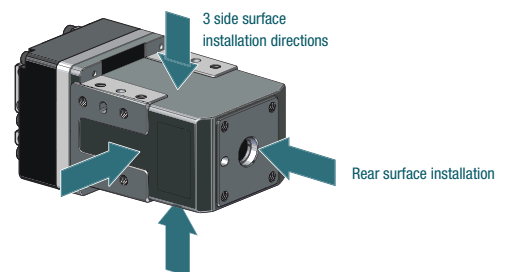

1 Grip

Reliably Grip Loads that may Easily Deform or Break.

Easily set the grip force, grip time, and speed according to the object being gripped.

Safely and reliably grip objects that may easily break, such as glass, and objects that easily deform, such as plastic or springs.

Quick Approach, Slow Grip

The motor approaches the load at high speed, then decelerates just before contacting the surface at low speed.

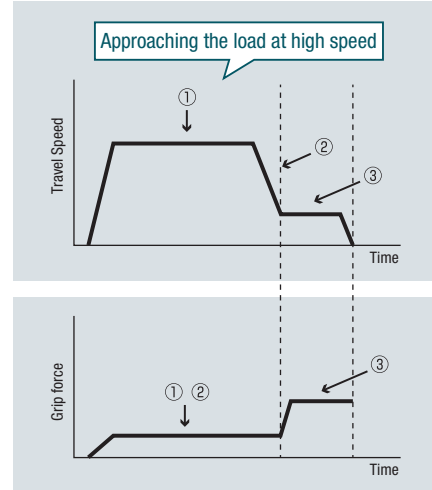
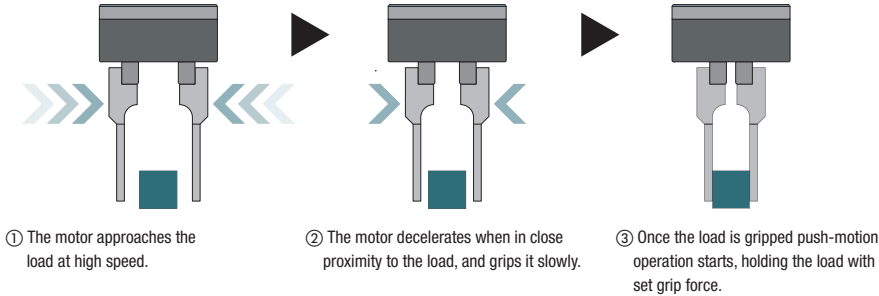

Grips at Low Grip Force, then Gradually Increases the Force

Pushing force and timing can be easily changed.

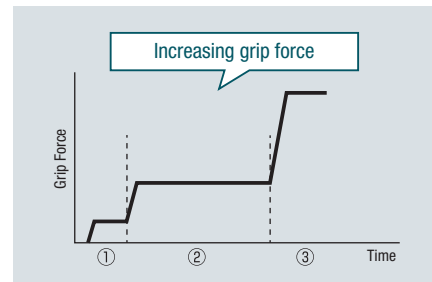
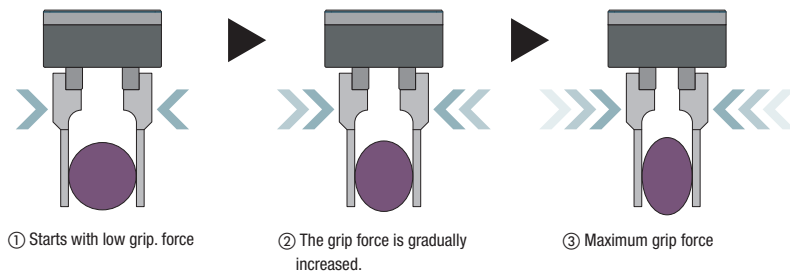

Grip Force Characteristics during Push-Motion Operation

The grip movement of the electric gripper works by utilising push-motion operation. The pushing force (grip force) is set according to the running current of the motor.

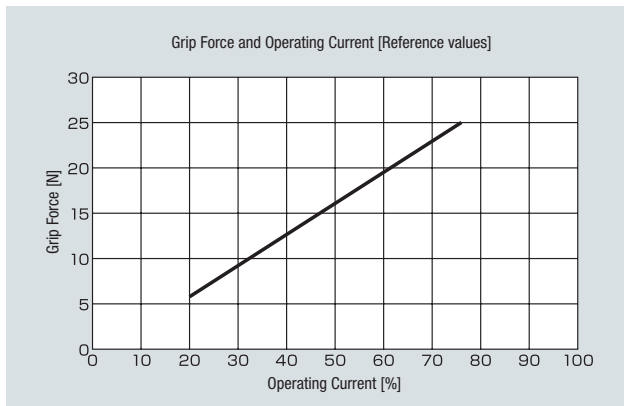

Maximum grip force **25 N**
 [Grip force range (reference value) Approx. 6 N~25 N]

● Push-motion operation speed max. 10 mm/s (per side)

2 Adjust

The Direction and Position of the Load can be Coordinated.

The minimum travel distance between the pincers - attached to the base jaws - is 0.02 mm. The direction and position of components can be coordinated by gripping them according to their size.

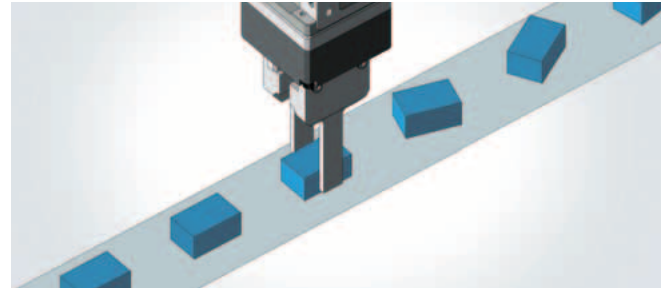
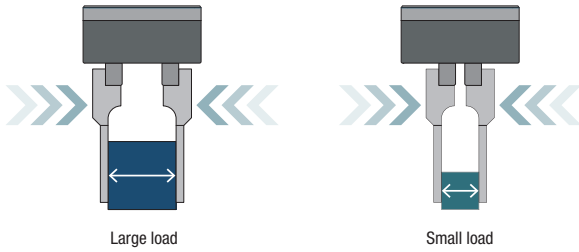

Pincers are not included with the product, and must be supplied by the customer.

3 Measure

The Size of the Load can be Verified without an External Sensor.

The Size and Presence of a Load are Determined within the Operational Range of the Pincers

The operational range of the pincer is confirmed by the output signal (TLC output, AREA output) from the driver, allowing the size and presence of a load to be determined.

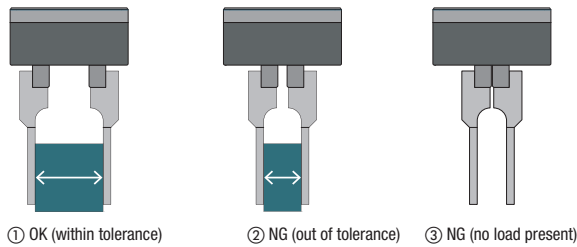

①② Determine of size of load

The position of the attachment when the load is gripped is confirmed, allowing for sorting by size.

③ Detect the presence of a load

Determine whether or not a load is gripped.

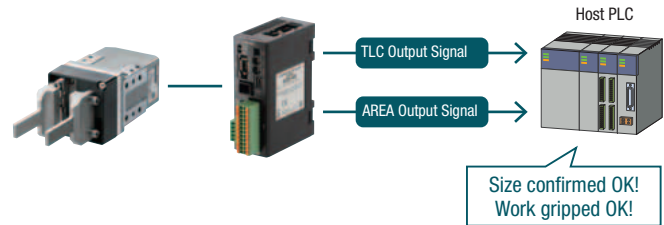

* AREA output: This signal is output when the motor is in a set area.

TLC output: This signal is output during push-motion operation when the output torque reaches a set torque limit value.

Monitor the Gripper Position to Measure Size

The Coordinates Information Monitoring Function in the driver sends data from the gripper to the host PLC, allowing the size of the load to be measured.

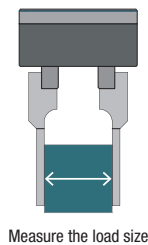

* Coordinates information monitoring function: This function sends position data to the host system.

Product Line

Electric Gripper



EH Series

AZ Series Driver (DC Input)

Built-in Controller Type

C-FLEX

The positioning data is set in the driver (256 points). Using a network converter (sold separately) facilitates control via FA network.



Pulse input type with RS-485 communication

RS-485 communication allows the motor's position, speed, torque, alarm, and temperature to be monitored.



Pulse Input Type

Controls the motor from a positioning module (pulse generator).



Network-Compatible Multi-Axis Driver

- EtherCAT-compatible
- SSCNETIII/H-compatible
- MECHATROLINKII-compatible



System Configuration

Combination of Electric Gripper and Built-in Controller Type Driver, or Pulse Input Type Driver with RS-485 Communication

A configuration example of a built-in controller type driver using either I/O control or RS-485 communication is shown below. Motor, driver, and a connection cable/flexible connection cable are ordered separately.

For a pulse input type driver system configuration, please see the Oriental Motor website.

- Required for operation
- Optional accessory

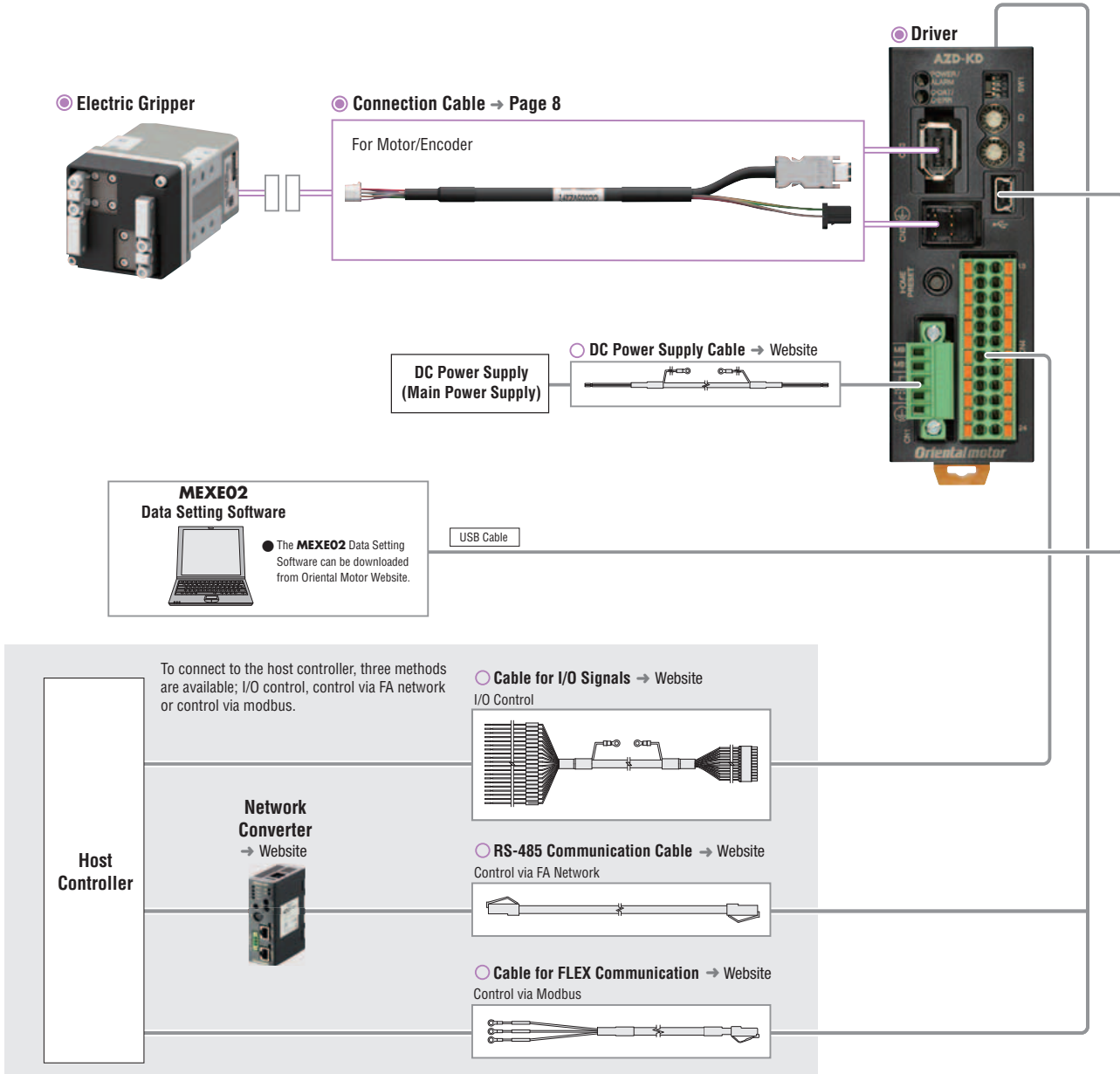

Example of System Configuration Pricing

Electric Gripper	Driver	Cable	
		Connection Cable (1 m)	Cable for I/O Signals Connector Type (1 m)
EH4-AZAKH	AZD-KD	CC010VZ2F2	CC16D010B-1
\$759.00	\$441.00	\$35.00	\$25.00
●	●	●	○

The system configuration shown above is an example. Other combinations are also available.

Note

The motor cable and encoder cable from the motor cannot be connected directly to the driver. When connecting to a driver, use a connection cable.

Product Number

Electric Gripper

EH 4 - AZ A K H

① ② ③ ④ ⑤ ⑥

Driver

AZD - K D

① ② ③

Connection Cable/Flexible Connection Cable

CC 050 V Z 2 F 2

① ② ③ ④ ⑤ ⑥ ⑦

①	Series Name	EH: EH Series
②	Frame Size	4: 46 mm (W)×46 mm (H) (Base Jaw Side)
③	Equipped Motor	AZ: AZ Series
④	Additional Function	A: Without Additional Function
⑤	Motor Specifications	K: DC Power Supply Input
⑥	Cable Outlet Direction	H: Horizontal Direction

①	Driver Type	AZD: AZ Series Driver
②	Power Supply Input	K: 24 VDC
③	Type	D: Built-in Controller Type X: Pulse Input Type with RS-485 Communication Blank: Pulse Input Type

①		CC: Cable
②	Length	005: 0.5 m 010: 1 m 015: 1.5 m 020: 2 m 025: 2.5 m 030: 3 m 040: 4 m 050: 5 m 070: 7 m 100: 10 m 150: 15 m 200: 20 m
③	Reference Number	
④	Applicable Model	Z: AZ Series
⑤	Motor Frame Size	2: 28 mm
⑥	Cable Type	F: Connection Cable R: Flexible Connection Cable
⑦	Cable Specifications	2: DC Power Supply Input

Product Line

● Electric Gripper



Product Name	List Price
EH4-AZAKH	\$759.00

● Driver

◇ Built-in Controller Type



Product Name	List Price
AZD-KD	\$441.00

◇ Pulse Input Type with RS-485 Communication



Product Name	List Price
AZD-KX	\$441.00

◇ Pulse Input Type



Product Name	List Price
AZD-K	\$384.00

● Connection Cable/Flexible Connection Cable

Use a flexible connection cable if the cable will be bent.

◇ For Motor/Encoder



Product Line	Name	Product Name	List Price
Connection Cable	0.5	CC005VZ2F2	\$35.00
	1	CC010VZ2F2	\$35.00
	1.5	CC015VZ2F2	\$43.00
	2	CC020VZ2F2	\$50.00
	2.5	CC025VZ2F2	\$56.00
	3	CC030VZ2F2	\$62.00
	4	CC040VZ2F2	\$97.00
	5	CC050VZ2F2	\$110.00
	7	CC070VZ2F2	\$136.00
	10	CC100VZ2F2	\$176.00
Connection Cable	15	CC150VZ2F2	\$243.00
	20	CC200VZ2F2	\$310.00

Product Line	Name	Product Name	List Price
Flexible Connection Cable	0.5	CC005VZ2R2	\$84.00
	1	CC010VZ2R2	\$84.00
	1.5	CC015VZ2R2	\$91.00
	2	CC020VZ2R2	\$99.00
	2.5	CC025VZ2R2	\$105.00
	3	CC030VZ2R2	\$111.00
	4	CC040VZ2R2	\$125.00
	5	CC050VZ2R2	\$141.00
	7	CC070VZ2R2	\$180.00
	10	CC100VZ2R2	\$236.00
Flexible Connection Cable	15	CC150VZ2R2	\$332.00
	20	CC200VZ2R2	\$426.00

Included

● Electric Gripper

Operating Manual: 1 Copy

● Driver

Type	Included	Connector	Operating Manual
Common to All Types		CN4 Connector (1 pc.) CN1 Connector (1 pc.)	1 Copy

● Connection Cable/Flexible Connection Cable

Type	Included	Operating Manual
Connection Cable		—
Flexible Connection Cable		1 Copy

AZ Series Catalogue

The driver and the cable are the same as in the **AZ** Series. Please see our separate catalogue for details of the **AZ** Series product range.

- Driver specifications
- RS-485 communication specifications
- Dimensions
- Connection and operation
- Cable

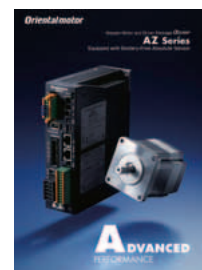

Specifications

Actuator Product Name		EH4-AZAKH
Maximum Grip Force [N]		25
Repetitive Positioning Accuracy [mm]	each side	±0.02
Backlash [mm]	each side	0.1
Stroke [mm]		25
	each side	12.5
Maximum Speed [mm/s]		156
	each side	78
Push Speed [mm/s]		20
	each side	10
Minimum Travel Amount [mm]		0.02
	each side	0.01
Permissible Load [N]		5
Static Permissible Moment [Nm]*		M _P : 1.2 M _Y : 0.12 M _R : 0.4

*The static permissible moment at base jaw tip. The load, attachment mass, grip force (including impact load), etc. should be considered when using.

Note

● The actual load mass that can be transported varies greatly depending on the attachment, the friction coefficient of the load, and the acceleration. Use it with a sufficient margin, with an upper limit of 1/10 of the grip force.

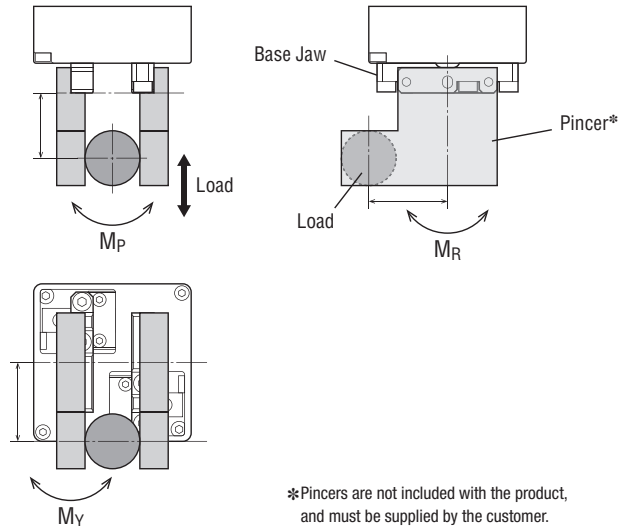

*Pincers are not included with the product, and must be supplied by the customer.

● Load Moment Formula

$$\frac{|\Delta M_P|}{M_P} + \frac{|\Delta M_Y|}{M_Y} + \frac{|\Delta M_R|}{M_R} \leq 1$$

ΔM_P : Load moment in the pitching direction (Nm)

ΔM_Y : Load moment in the yawing direction (Nm)

ΔM_R : Load moment in the rolling direction (Nm)

M_P : Permissible moment in the pitching direction (Nm)

M_Y : Permissible moment in the yawing direction (Nm)

M_R : Permissible moment in the rolling direction (Nm)

Specification Table Glossary

Maximum Grip Force	This is a maximum force to grip the load.
Repetitive Positioning Accuracy	A value indicating the amount of error that is generated when positioning is performed repeatedly to the same position in the same direction. (The accuracy is measured at a constant temperature under a constant load.)
Backlash	The play of the base jaws when the motor shaft is fixed.
Stroke	The maximum distance the base jaws can be opened and closed.
Maximum Speed	The maximum speed the base jaws can be opened and closed.
Push Speed	The operation speed during push-motion operation (gripping motion).
Minimum Travel Amount	The amount of movement per pulse set at the time of shipment.
Permissible Load	Allowable external force.
Static Permissible Moment	The moment allowed while gripping.

Relationship between Push Force (Grip Force) and Current

The gripping movement of the electric gripper depends on the push-motion operation. The push force (grip force) is set by the operating current of the motor.

Actual Push Force (Grip Force)

The push force (grip force) and current values are shown below as a reference. Check it on the actual assembled equipment.

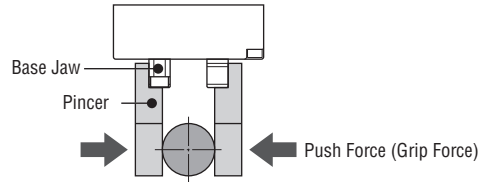
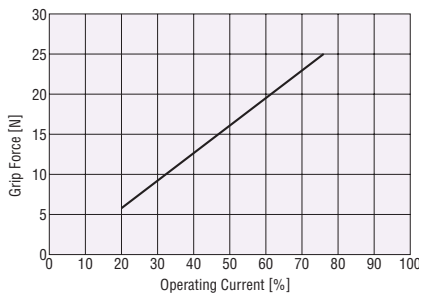

- Set the grip force during push-motion operation to 25 N or less.
- Set the operation speed during push-motion operation to 10 mm/s or less (single side)

Driver Specifications

Product Name		AZD-KD, AZD-KX, AZD-K
Power Supply Input	Voltage	24 VDC ±5%
	Input Current A	1.4

General Specifications

		Electric Gripper	Driver
Thermal Class		130 (B)	—
Insulation Resistance		The measured value is 100 MΩ or more when a 500 VDC megger is applied between the following locations: <ul style="list-style-type: none"> • Between the case and motor windings 	The measured value is 100 MΩ or more when a 500 VDC megger is applied between the following locations: <ul style="list-style-type: none"> • Between the protective earth terminal and the power supply terminal
Dielectric Strength		Sufficient to withstand the following for 1 minute: <ul style="list-style-type: none"> • Between the case and motor windings: 1.5 kVAC, 50 Hz or 60 Hz 	—
Operating Environment (In operation)	Ambient Temperature	0 to +40°C (Non-freezing)*	0 to +50°C (Non-freezing)
	Ambient Humidity	85% or less (non-condensing)	
	Atmosphere	Use in an area without corrosive gases and dust. The product should not be exposed to water, oil or other liquids.	
Degree of Protection		—	IP10

*Based on Oriental Motor's internal measurement conditions

Note

- Disconnect the motor and driver when taking an insulation resistance measurement or performing a dielectric voltage withstand test. Also, do not perform these tests on the absolute sensor part of the motor.

Travel Direction

The default factory setting for direction of travel is as follows:

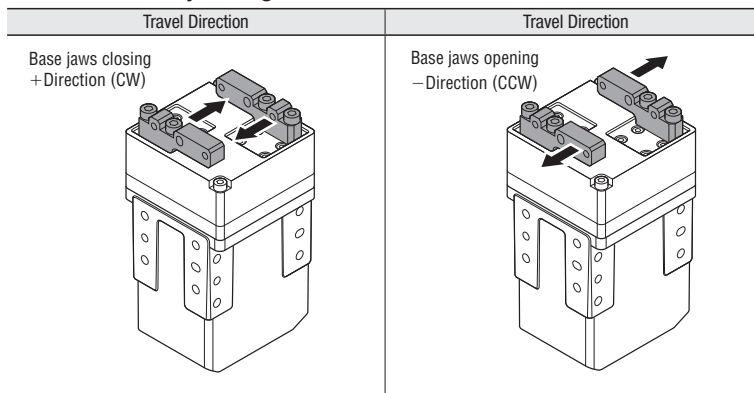

Dimensions (Unit: mm)

Product Name	Mass kg (lbs)
EH4-AZAKH	0.38 (0.84)

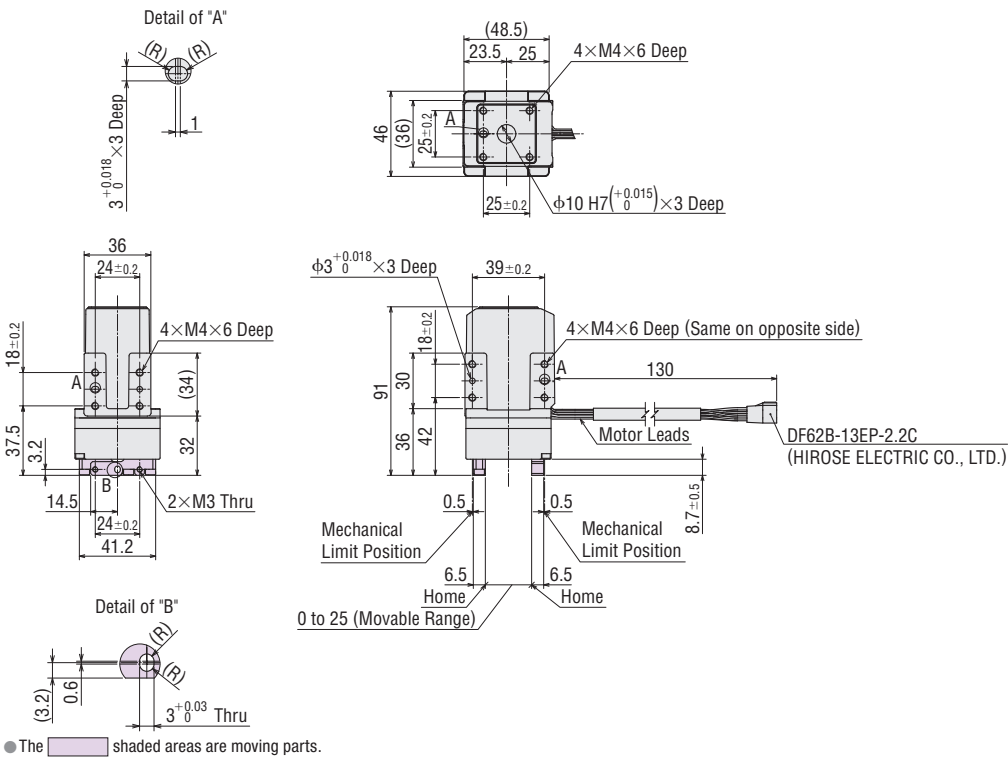

Product Variation with the AZ Series

Controllability is consolidated across all product groups that contain the **AZ** Series.



Battery-Free
Absolute Sensor

AZ Series

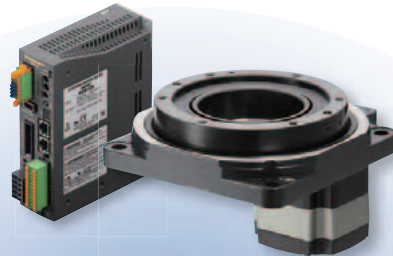

Hollow Rotary
Actuator

DGII Series



Compact Linear
Actuator

DRS Series

Simplify Setup & Control



Electric Linear Slides

EZS Series



Electric Cylinders

EAC Series

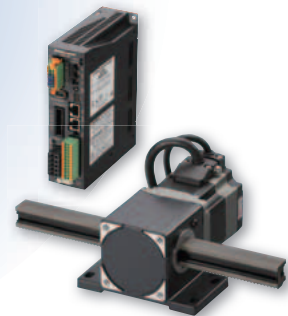

Rack & Pinion

L Series

Specifications are subject to change without notice. This catalog was published in January, 2020.

ORIENTAL MOTOR U.S.A. CORP.

Western Sales and Customer Service Center

Tel: (310) 715-3301 Fax: (310) 225-2594

Los Angeles

Tel: (310) 715-3301

San Jose

Tel: (408) 392-9735

Midwest Sales and Customer Service Center

Tel: (847) 871-5900 Fax: (847) 472-2623

Chicago

Tel: (847) 871-5900

Detroit

Tel: (734) 808-0003

Dallas

Tel: (214) 432-3386

Toronto

Tel: (905) 502-5333

Eastern Sales and Customer Service Center

Tel: (781) 848-2426 Fax: (781) 848-2617

Boston

Tel: (781) 848-2426

Charlotte

Tel: (704) 766-1335

New York

Tel: (973) 359-1100

Technical Support

Tel: (800) 468-3982 / 8:30 A.M. to 5:00 P.M., P.S.T. (M-F)
7:30 A.M. to 5:00 P.M., C.S.T. (M-F)

E-mail: techsupport@orientalmotor.com

Obtain Specifications, Online Training
and Purchase Products at:
www.orientalmotor.com

Copyright ©2019 ORIENTAL MOTOR U.S.A. CORP.

This printed material uses ECF (Elemental
Chlorine Free) paper and vegetable oil based inks.
This combination is environmentally friendly.

Printed in USA 200 1K 2.76 #538